

Lawrence Berkeley National Laboratory

Recent Work

Title

BALLISTIC DEFICIT CORRECTION IN SEMICONDUCTOR DETECTOR SPECTROMETERS

Permalink

<https://escholarship.org/uc/item/9zj5f30v>

Authors

Goulding, F.S.

Landis, D.A.

Publication Date

1987-10-01

e.2



Lawrence Berkeley Laboratory

UNIVERSITY OF CALIFORNIA

Engineering Division

RECEIVED
LAWRENCE
BERKELEY LABORATORY

FEB 1 1988

LIBRARY AND
DOCUMENTS SECTION

Presented at the IEEE 1987 Nuclear Science Symposium, San Francisco, CA, October 21-23, 1987, and to be published in the Proceedings

Ballistic Deficit Correction in Semiconductor Detector Spectrometers

F.S. Goulding and D.A. Landis

October 1987

TWO-WEEK LOAN COPY
This is a Library Circulating Copy which may be borrowed for two weeks.

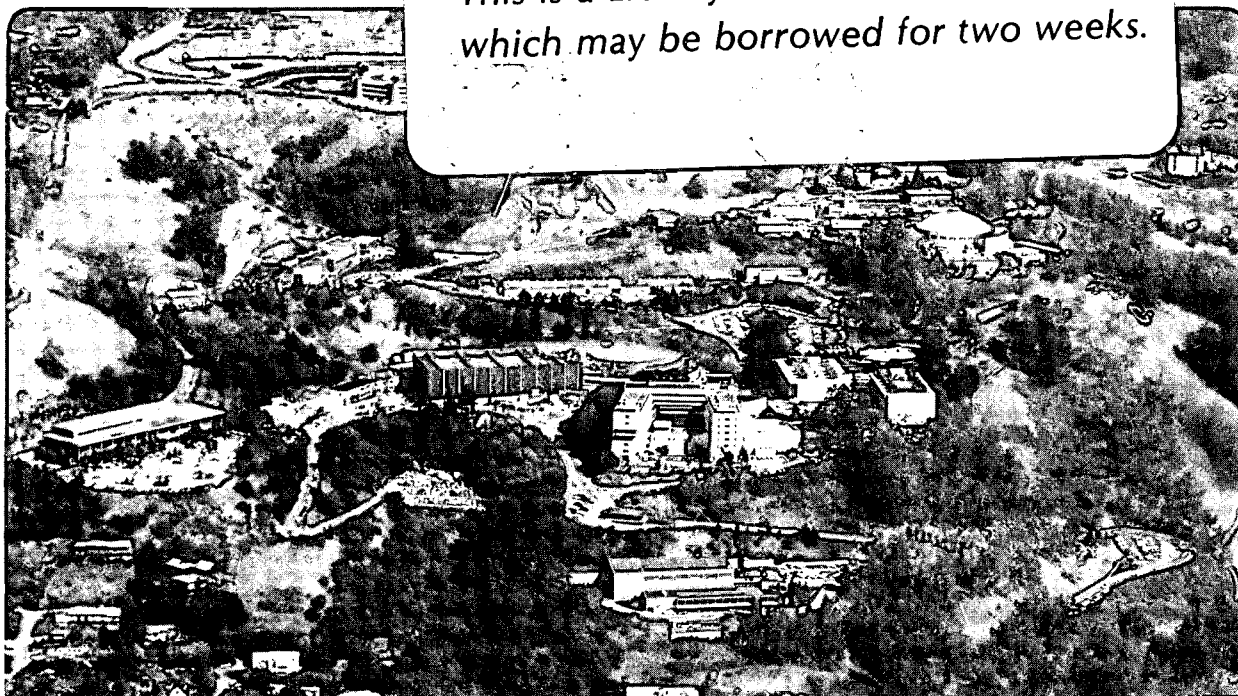

LBL-22195
e.2

DISCLAIMER

This document was prepared as an account of work sponsored by the United States Government. While this document is believed to contain correct information, neither the United States Government nor any agency thereof, nor the Regents of the University of California, nor any of their employees, makes any warranty, express or implied, or assumes any legal responsibility for the accuracy, completeness, or usefulness of any information, apparatus, product, or process disclosed, or represents that its use would not infringe privately owned rights. Reference herein to any specific commercial product, process, or service by its trade name, trademark, manufacturer, or otherwise, does not necessarily constitute or imply its endorsement, recommendation, or favoring by the United States Government or any agency thereof, or the Regents of the University of California. The views and opinions of authors expressed herein do not necessarily state or reflect those of the United States Government or any agency thereof or the Regents of the University of California.

F.S. Goulding and D.A. Landis

Lawrence Berkeley Laboratory
University of California
Berkeley, California 94720 U.S.A.ABSTRACT

At high energies, the energy resolution of γ -ray spectrometers using large-diameter coaxial germanium detectors can be dominated by "ballistic deficit" effects, particularly when short processing times are used to permit high rate operation. This results from the fact that rise-time variations in the detector signal are reflected in amplitude fluctuations after the signals pass through pulse shapers. The paper describes a method of compensating for these effects on a pulse by pulse basis using the fact that the loss of amplitude for slowly-rising signals is accompanied by a delay in the peak time of the shaped output signal. The simple analog corrector circuit uses a relationship whereby the amplitude deficit is roughly proportional to the square of the time delay in the peak. Results show considerable improvements in the energy resolution of germanium γ -ray spectrometers at high energies.

INTRODUCTION

The measurement of a signal produced by a semiconductor detector should ideally be a ballistic measurement resulting in an output reading proportional to the charge produced by a radiation event in the detector. This reading should be independent of the charge collection time in the detector. Such a result can be accomplished if the measurement is made in a very long time compared with the detector charge collection time, but the measurement time in a spectrometer is normally limited by the need to process signal pulses occurring at random times and at relatively high rates. Furthermore, parallel noise increases if long processing times are used. Consequently, the pulse shaping circuits used in spectrometers are designed to produce output pulses whose total duration is usually limited to a few microseconds and the peak amplitude of the output pulse, which occurs at a time less than half the pulse width, is used as a measure of the input charge signal from the detector. For large coaxial germanium γ -ray detectors and thick silicon charged particle detectors, charge collection times fluctuate between events (depending on the location of interactions) and may approach 1 μ s. Consequently, the conditions for a ballistic measurement are not satisfied and "ballistic deficit" effects occur.

As a result of these "ballistic deficit" effects, the fluctuations in the detector charge signal rise time are reflected in fluctuations in the peak amplitude of the output signal from the pulse shaper. Under some circumstances these ballistic deficit fluctuations can be a major or dominant contributor limiting resolution. In a γ -ray spectrometer the contributions to resolution are primarily due to:

- a) Electronic noise produced by noise in the channel of the input field effect transistor (FET) and by noise in any input circuit current or parallel resistive elements. This type of noise is independent of the energy of photons interacting in the detector. We will assume a FWHM resolution E_n due to this source.

- b) Statistics associated with the charge production process in the detector. The original photon interaction produces high energy electrons that result in electron-hole showers in the semiconductor. During the creation of the showers, energy losses occur both to ionizing processes (which result in signal charge) and to vibrational (thermal) processes (with no resulting signal). The statistical sharing of energy between these processes results in an FWHM resolution given by:

$$E_c = 2.35 \sqrt{FE\epsilon} \quad (1)$$

where: F is the Fano Factor (~ 0.12)
E is the photon energy, and
 ϵ is the average energy required to produce a hole-electron pair (2.96 eV in Ge at 77°K)

To first order, fluctuations in trapping during charge collection result in an apparent increase in the value of F. Trapping fluctuations are approximately proportional to \sqrt{E} due to the average number of trapped carriers being almost proportional to E.

- c) The absolute value of the ballistic deficit contribution is proportional to signal amplitude. Therefore, these effects can be expressed as a resolution contribution $E_b = AE$ where A is a constant independent of E.

Combining these three terms in quadrature, the total resolution E_T is given by:

$$E_T^2 = E_n^2 + 2.35^2 FE\epsilon + A^2E^2 \quad (2)$$

This result indicates that the system resolution is dominated by electronic noise at low energies while charge production statistics become important at somewhat higher energies and ballistic deficit effects may become dominant at very high energies. Modern germanium γ -ray detector spectrometers exhibit this behavior and the importance of ballistic deficit effects has grown as large diameter high-efficiency detectors have become available.

The magnitude of the ballistic deficit effect depends both on the type of pulse shaper employed and on the ratio of the characteristic shaper time to the variations in the detector signal rise time. A shaper with a step function response exhibiting a flat top for a time greater than the maximum detector signal rise time will result in zero deficit - that is, the peak amplitude of the output signal is independent of input signal rise time. The gated integrator shaper¹ comes close to achieving this result and was developed specifically to reduce ballistic deficit effects. Unfortunately, the gated integrator is complex and is sensitive to low frequency noise (parallel input circuit components and detector leakage) and to baseline fluctuations in the signal feeding the gated integrator. These factors make the gated integrator a difficult circuit to design and to use in an optimum manner.

The common passive shapers used in γ -ray spectrometers generally produce quasi-Gaussian shaped output pulses. Because the shapes produced by these circuits do not exhibit flat tops, ballistic deficit effects occur. The purpose of the technique described here is to correct (on a pulse by pulse basis) for the deficit present in such spectrometers and thereby to reduce the output signal fluctuations caused by fluctuations in the input signal rise time.

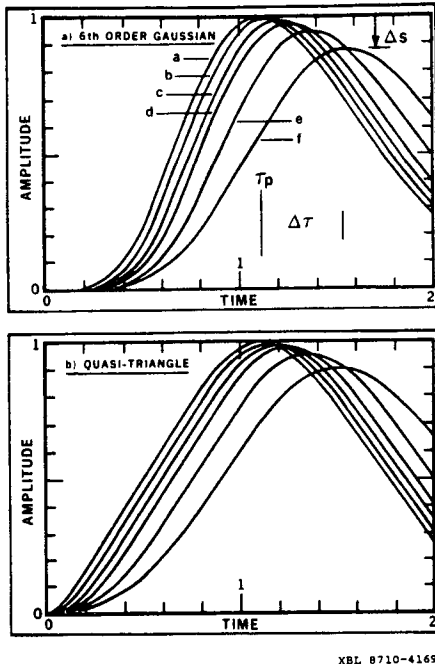

Fig. 1: Output signal pulse shapes for two types of shaper fed by linearly rising signals with different rise times. The upper figure is for a simple 6th order Gaussian while the lower figure is for a quasi-triangular shape. Curves a-f correspond to ratios of rise time/peaking time of 0, .1, .2, .3, .5 and .8.

MAGNITUDE OF THE BALLISTIC DEFICIT

For the purpose of initial discussion consider a simple pulse shaper consisting of a single RC differentiator (time constant τ_D) and a sequence of 6 RC integrators (also time constant τ_D). The step function response for such a shaper, shown in Fig. 1a, peaks at a time $\tau_p = 6\tau_D$. The shapers commonly used in spectrometers employ active integrator circuits with complex poles in order to produce faster recovery on the back edge of the output shape. However, the simple Gaussian shaper used in our analysis behaves, in general, in a similar way to the more complex spectrometer shapers in regard to ballistic deficit.

A further simplification will be made by assuming that the input signal exhibits a linear rise with a total rise time τ_r (i.e., the detector signal current is constant during the charge collection process and is integrated in the charge sensitive preamplifier to produce a linear rise). The convolution integral method can be used to analyze the output shape from the 6th-order Gaussian for different linear signal rise times. The results are shown in Fig. 1a. As expected, the peak signal deficit increases as the rise time increases from zero (curve a) to 80% of the step function peaking time (curve f). Figure 1b shows the behavior of the quasi-triangular pulse shaper². This behavior is similar to that of Fig. 1a but with a smaller absolute value of the deficit due to the somewhat flatter

topped pulse shape. In both cases, we note that the time of the output signal peak is delayed as the signal rise time increases. The dotted line of Fig. 2 shows a plot of the deficit (expressed as a percentage) as a function of the peak delay time with the triangles being points for the triangular shaper while the circles are for the simple Gaussian. As can be seen from this graph and the full line, the ballistic deficit is approximately given by:

$$\frac{\Delta s}{S_0} = \left(\frac{\Delta \tau}{\tau_D} \right)^2 \quad (3)$$

where: Δs = peak signal amplitude deficit
 S_0 = peak amplitude for zero signal rise time
 Δ = peak delay
 p = peaking time for output with zero signal rise time.

Although not expressed exactly in this form, a classical paper³ by Baldinger and Franzen derives this approximate result using a purely analytical approach. This method has also been used in a recent paper⁴.

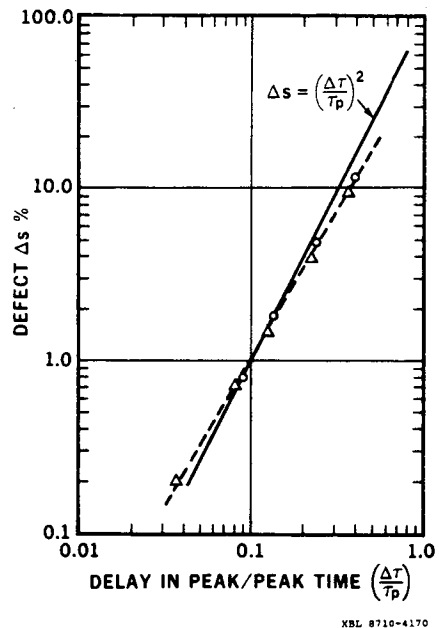

Fig. 2: The dotted line shows the relationship between the output signal ballistic deficit and the peak delay; these results are derived from Fig. 1. The circles are points for the 6th order Gaussian while the triangles are points for the quasi-triangular. The full line shows a square law relationship.

The simplicity of the result given in Eq. 3 is deceptive; it can be shown that it is only valid with the following constraints:

- The peak region of the shaper step function response can be approximately represented by a parabola.
- The input detector signals all have the same basic shape but fluctuate in their time scale.

Fortunately, the practical situation in a large germanium detector spectrometer comes close to satisfying these conditions; the relationship of Eq. 3 can be used as a basis for a ballistic deficit correction circuit.

CIRCUIT DESIGN

Figure 3 shows an example of the modification required to a typical spectrometer pulse processor in order to achieve the ballistic deficit correction and Fig. 4 shows the important waveforms. The elements added in the block diagram are shown shaded; the remaining blocks (or their equivalent) exist in many standard spectrometers. The particular spectrometer used in this example includes a second differentiator and cross-over discriminator fed from the input to the final active integrator stage to produce a timing pulse [2] at the peak time of the main output signal [1]. It also includes a signal stretcher producing a stretched output [3] which feeds a linear gate that is opened for a short time to produce a square output pulse [4] whose output is equal to the peak amplitude of [3]. A fast amplifier and discriminator is used to pick off a "start" signal [5] for use in the pile-up rejector and width one-shot circuits.

The pile-up rejector inspects for a second start pulse occurring before the time of the peak of the main signal pulse [2] while the width one-shot, set to the full width of the signal pulse [1], is used to gate off the action of the baseline restorer during signal pulses, so that it effectively clamps the signal baseline even at very high event rates.

Additional elements required for the ballistic deficit correction include:

a) A delay circuit triggered by the "start" signal [5] and adjusted for a delay equal to the peak time of a signal produced by a perfect step function (i.e., zero rise-time) input signal. In practice, a fast rising pulser step function is fed through the detector or into a test capacitor at the preamplifier input and the delay is adjusted to produce a back-edge [6] at precisely the peak time of the output signal [2] as shown dotted in Fig. 4.

For normal detector signals (shown as full line in Fig. 4) the peak time [2] occurs later so output [6] occurs earlier than [2].

b) A flip-flop set by waveform [6] is normally reset by the peak signal [2]. The output of this flip-flop [7] is therefore a square pulse of width equal

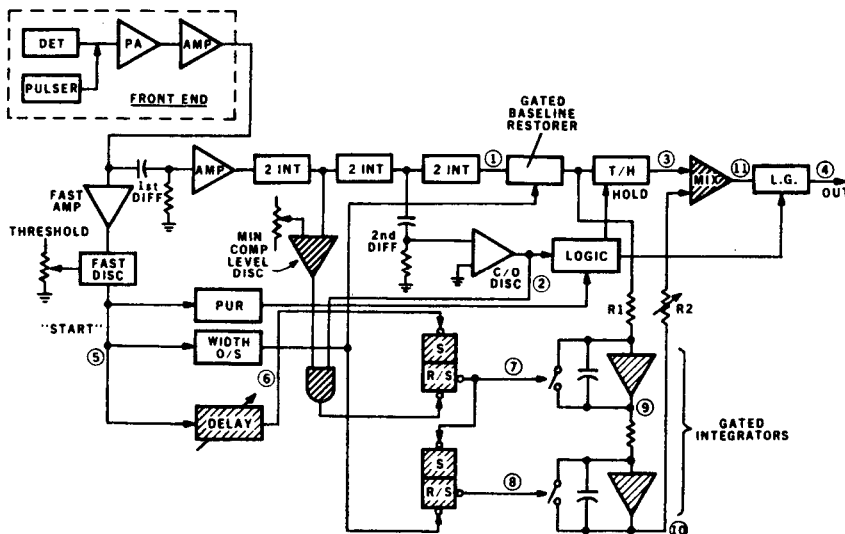

Fig. 3: Schematic diagram of the modifications made to a pulse processor to achieve the ballistic deficit correction. The shaded blocks represent added elements.

to the value of $\Delta\tau$ (Eq. 3). A comparison discriminator prevents the setting of this flip-flop unless the signal exceeds a certain level (~ 50 keV) so that no compensation is applied to low-energy signals.

- c) A second flip-flop is set at the same time as the first one and reset at the end of the width one-shot. It provides the waveform [8].
- d) The outputs of the two flip-flops are used to open MOS FET switches that normally short out the integrating capacitors of two sequential integrators. The input current for the first integrator is obtained via R_1 from the signal; therefore, the first integrator produces an output at [9] proportional to $S_0 \cdot \Delta\tau$ where S_0 is the signal amplitude. The second integrator produces an output [10] amplitude proportional to $S_0 \cdot \Delta\tau^2$. As can be seen from Eq. 3 (for a fixed value of τ_D) this is proportional to the required ballistic deficit correction signal.

While the first integrator is reset when the first flip-flop resets, the charge on the integrating capacitor of the second integrator is retained from the peak to the end of the main signal.

- e) A mixing amplifier is provided before the final output linear gate to add the correction signal [10] to the main output signal [3] thereby resulting in a corrected signal [11]. The amount of the correction signal is determined by adjustment of R_2 . Because the correction signal is zero at low energies, the effect of the parallel compensating channel on electronic noise is negligible.

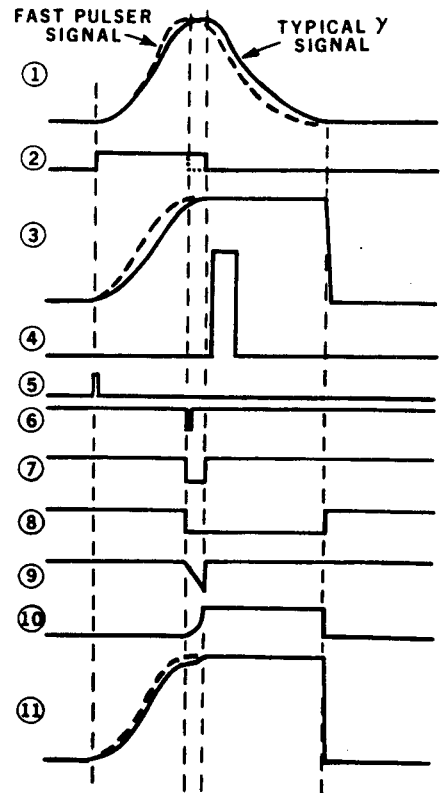

XBL 8710-4172

Fig. 4: Waveforms applicable to Fig. 3. The ID numbers of the waveforms correspond to those in Fig. 3.

The particular circuit described here is an example of a modification to a specific spectroscopy amplifier. Similar designs can be generated to perform the correction in the case of other amplifiers but the detailed designs may differ somewhat from that given here. The experimental results presented in the next section were obtained with this design.

EXPERIMENTAL RESULTS

The purpose of this section is to illustrate the performance improvement resulting from the use of the corrector circuit in spectrometers employing some typical large coaxial detectors. Three detectors were used in this initial study:

- A p-type coaxial detector 5.2 cm diam with a total volume of 120 cm³ (detector A),
- An n-type coaxial detector ~ 5.5 cm diam with a total volume of 150 cm³ (detector B). In common with many n-type detectors, a significant amount of electron trapping is present in this detector.
- A p-type coaxial detector 5.6 cm diam with a total volume of 160 cm³ (detector C).

All measurements were performed with an amplifier producing a 6th-order Gaussian shaped output pulse modified to result in the quasi-triangular shape². As shown earlier, this shape exhibits a slightly flatter top than the simpler 6th-order Gaussian and, therefore, somewhat smaller ballistic deficit. The important tests to be performed are those that indicate the energy resolution when using shorter pulse shaping times than those commonly employed for such large detectors. For applications in the γ -ray energy range > 1 MeV, the detectors used in this study would commonly be used with shaping networks producing output pulses peaking at 12 μ s or more and therefore with total pulse widths of about 30-40 μ s. As a point of reference, a standard commercial system (peaking time 13 μ s) used with detector A yielded a full width at half maximum (FWHM) resolution of 2.23 keV at 1.33 MeV (⁶⁰Co) and a full width at 1/10 maximum (FWTM) of 4.25 keV.

Two parameters must be adjusted to achieve the desired compensation behavior over the full energy range:

- The delay produced by the delay circuit ([a] in the circuit description) must be adjusted so that the back edge of its output waveform occurs at the output pulse peak time for an infinitely fast step function input. This is accomplished using a fast rising pulse generator pulse fed either through the detector capacitance or a test capacitor to the preamplifier input. The delay adjustment is set to match the back edges of waveforms [6] and [2] in Figs. 3 and 4. Readjustment is required if the pulse shaping times are changed.
- The gain through the compensating circuit must be adjusted to result in the right amount of correcting signal. This can be done by observing the shape of high energy peaks in a spectrum and adjusting R2 (Fig. 3) to minimize the peak width, but a faster way is to use a pulser whose rise time alternates between a very small value and a value approximating that of a typical detector (~ 400 ns). The value of R2 is then adjusted so that the pulser peak in a spectrum is of minimum width (note that the two rise times cause a split peak in the absence of the ballistic deficit correction).

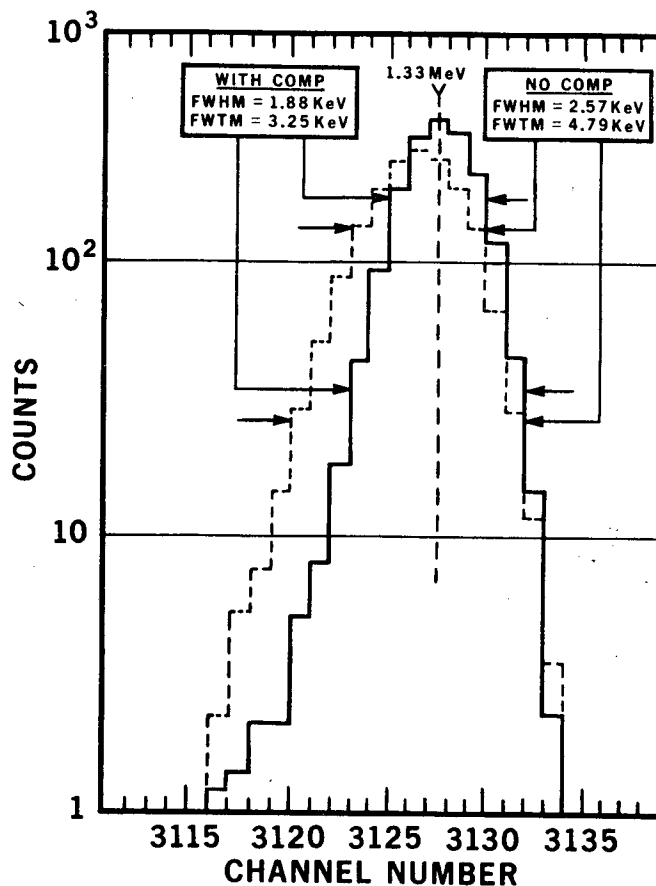

XBL 8710-4173

Fig. 5: Showing the ⁶⁰Co 1.33 MeV peak shapes for p-type coaxial detector A. The full line is for the case where the corrector circuit is used while the dotted line is for no correction. The detector was operated at 2.4 kV and a peaking time of 4 μ s was employed.

Figure 5 shows the shape of the 1.33 MeV ⁶⁰Co peak in a spectrum accumulated using detector A with a peaking time of 4 μ s. The detector was operated at its normal voltage of 2400 V. This figure shows the line shape for operation with the quasi-triangular shaper (dotted) with no compensation and with the compensation adjusted to its ideal value (full line). The uncompensated peak has been shifted slightly to allow simple comparison of peak shapes. A striking improvement in both the FWHM (1.88 keV vs. 2.57 keV) and the FWTM resolution (3.25 keV vs. 4.79 keV) is observed and the peak is almost perfectly symmetrical in the compensated case. We also note the substantial improvement compared with the commercial 13 μ s peaking time system (FWHM 1.88 keV vs. 2.23 keV and FWTM 3.25 keV vs. 4.25 keV). The shorter peaking time also means that operation at ~ 3 times the rate is possible. A further advantage of operating at shorter shaping times is greater tolerance to leakage current; this can make a detector usable at higher temperatures and after radiation damage - both of significant value in space applications. Another example of the performance with detector A, as well as a demonstration of the need for accurate setting of the corrector gain, is given in Fig. 6. Here a peaking time of 2 μ s is used and a large improvement in performance is again observed. However, the slight asymmetry of the peak in the case where the corrector is used and the fact that tailing exists on the high-energy side indicates that the gain of the corrector circuit is set too high for this particular case.

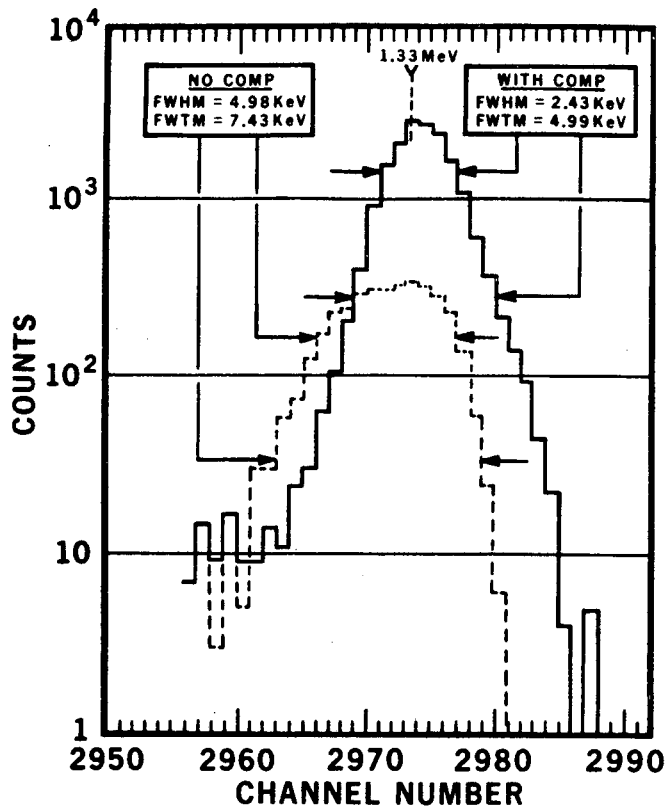

XBL 8710-4174

Fig. 6: As Fig. 5 but a peaking time of 2 μ s was used. Note the slight tailing on the high energy side of the peak due to a slight excess of correction being used in this case.

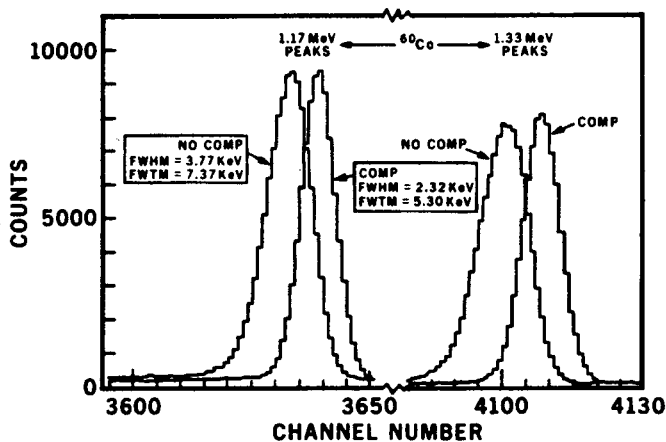

XBL 8710-4175

Fig. 7: Line shapes for both ^{60}Co peaks with and without the correction for n-type coaxial detector B. A peaking time of 1.5 μ s and a bias of 4 kV were employed.

Figure 7 shows the two ^{60}Co peaks (1.17 MeV and 1.33 MeV) as measured by the large n-type coaxial detector B using a peaking time of only 1.5 μ s. Despite the fact that this detector, like most n-type coaxial detectors shows significant electron trapping, the spectrum achieved using compensation exhibits excellent resolution for use at such a short shaping time.

The remaining figures show the spectral performance over a broad energy range using the very large p-type

coaxial detector C. This data is presented to show that the compensation is correct at all energies - a necessary condition for practical use of the method. All these spectra were accumulated with a peaking time of 3 μ s. Figure 8 shows the comparative line shapes (compensated and uncorrected) at 1.33 MeV while Fig. 9 shows the performance at 2.61 MeV. Figures 10-12 show the spectra obtained using a mixed source to demonstrate the comparative performance over the energy range from approximately 600 keV to 3 MeV. As indicated by the line shapes over this whole energy range, the compensation provides a substantial resolution improvement throughout this range. At lower energies, the effect of ballistic deficit becomes negligible and compensation is not needed.

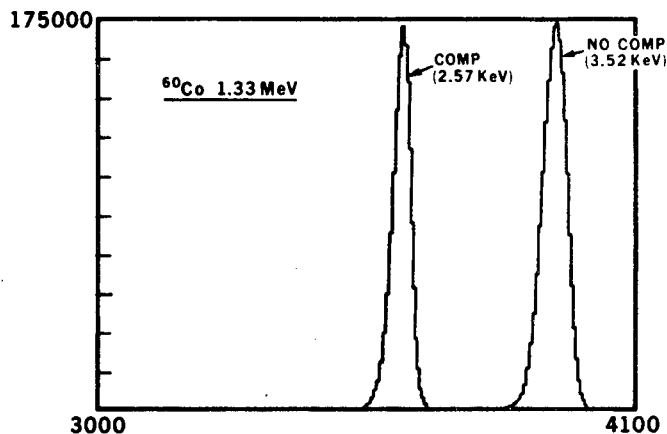

XBL 8710-4176

Fig. 8: ^{60}Co 1.33 MeV line shapes (compensated and uncorrected) for the p-type detector C used at only 1200 V with a peaking time of 3 μ s.

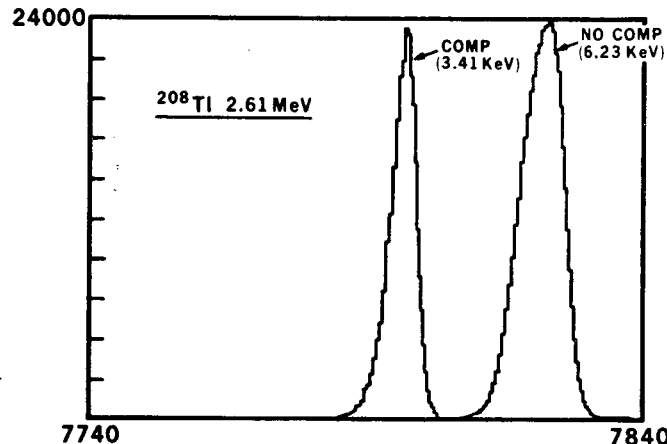

XBL 8710-4177

Fig. 9: As Fig. 8 but showing the line shape for the ^{208}Tl line at 2.61 MeV.

CONCLUSION

As indicated in the previous section, this simple ballistic deficit corrector circuit produces dramatic improvements in the energy resolution of Ge γ -ray spectrometers, particularly when used at high energies and the short peaking times necessary to permit counting at high rates. Further work is required to determine the value of the method in reducing the effects of charge trapping in detectors caused either by crystal defects or by radiation damage. One would expect that the method might be successful in reducing the effects

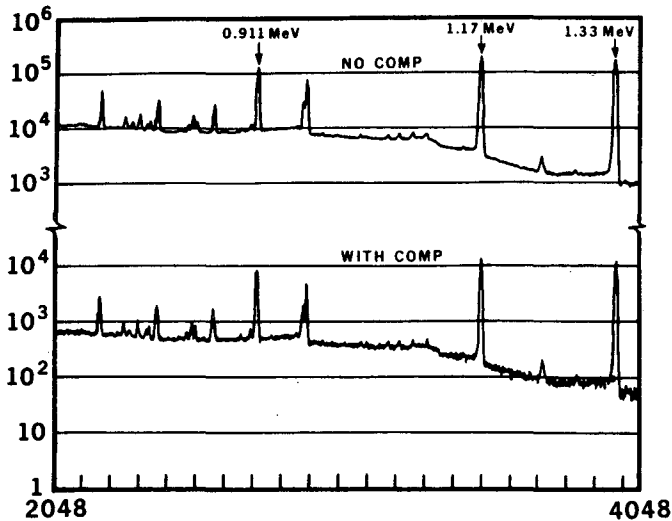

XBL 8710-4178

Fig. 10 Conditions as in Fig. 8. This shows a comparison using a mixed source in the energy range ~ 650 keV to 1.4 MeV of a spectrometer with and without compensation.

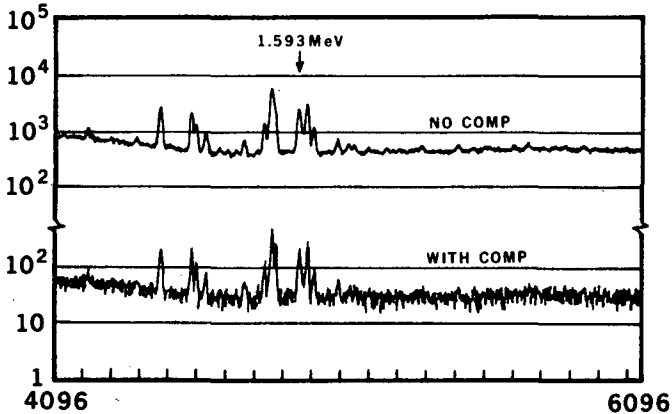

XBL 8710-4179

Fig. 11 As Fig. 10, but the energy range is approximately from 1.4 MeV to 2.0 MeV.

of shallow traps whose capture/emission times are substantially shorter than the signal processing time (i.e., the time at which the signal peak occurs). There is some evidence for this in the results for detector B which is made from n-type material that exhibits some electron trapping. If this result is confirmed, it may be very important in making it easier to produce n-type material suitable for high-grade large detectors. It is equally important to extend the radiation life of p-type and n-type detectors.

Use of the method in other detector applications also requires investigation. The technique is clearly applicable to improving linearity in charged particle spectrometers using thick silicon or germanium detectors where the long collection time and variations in particle range cause the ballistic deficit to result in a non-linear energy response that is dependent on particle type. Applications to ionization chambers and scintillation detectors also are possible.

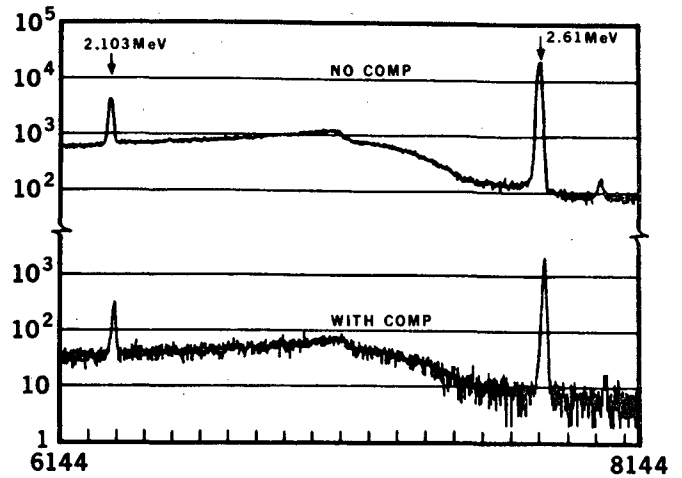

XBL 8710-4180

Fig. 12 As Fig. 10, but the energy range is approximately from 2.1 MeV to 2.7 MeV.

Finally, attention should be drawn to the possible usefulness of the method in correcting for non-linearity in certain types of germanium γ -ray spectrometers. In some cases, it is possible for non-linearities to arise due to the fact that low energy γ -rays interact in a small region near the surface while higher energy γ -rays interact by multiple Compton scattering followed by a photo-electric interaction; in this case, energy absorption occurs through the whole volume of the detector. This results in a statistically different distribution of rise times for signals of different energies and, consequently, different ballistic deficits. The effect is difficult to observe because the deficit is small for low energy events compared to the electronic noise effect on resolution. However, precise measurements of linearity would certainly reveal the non-linearity and use of the corrector circuit will eliminate it.

ACKNOWLEDGMENTS

We thank R.H. Pehl, P.N. Luke, A.R. Smith and N.W. Madden for their assistance and advice; the theoretical work of Dexi Gao and Billy Loo stimulated the thinking that led to the present work. This work was supported by the Director's Office of Energy Research, Office of Health and Environmental Research, U.S. Department of Energy under Contract No. DE-AC03-76SF00098.

REFERENCES

1. V. Radeka, IEEE Trans. Nucl. Sci., NS-19, No. 1, 412 (1972).
2. F.S. Goulding, D.A. Landis and N.W. Madden, IEEE Trans. Nucl. Sci., NS-30, No. 1, 301 (1983).
3. E. Baldinger and W. Franzen, Adv. in Elect. and Electron Phys., 255, Ed. L. Morton, Academic Press, NY (1956).
4. B.W. Loo, F.S. Goulding and D. Gao, "Ballistic Deficits in Pulse Shaping Amplifiers", to be presented at the IEEE Nucl. Sci. Symp., Oct. 1987.
5. The principle of this compensation method is the subject of a DOE patent application.

*LAWRENCE BERKELEY LABORATORY
TECHNICAL INFORMATION DEPARTMENT
UNIVERSITY OF CALIFORNIA
BERKELEY, CALIFORNIA 94720*